

Front View

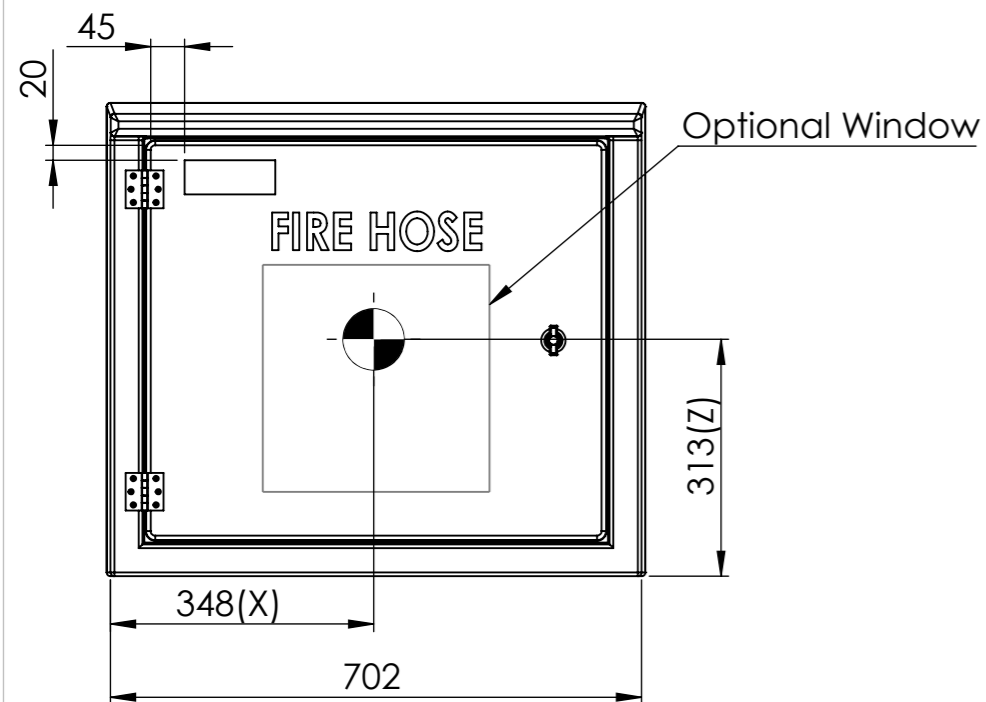

Side View

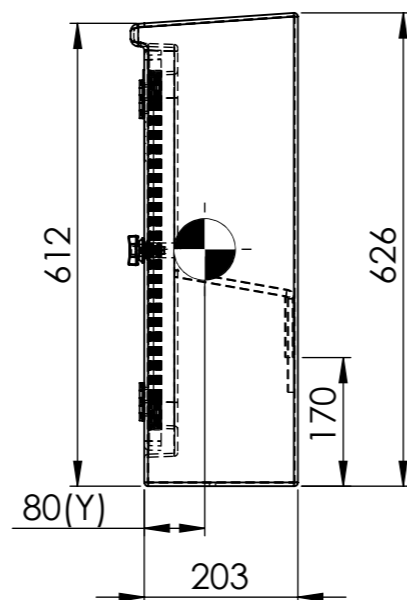

ISO View

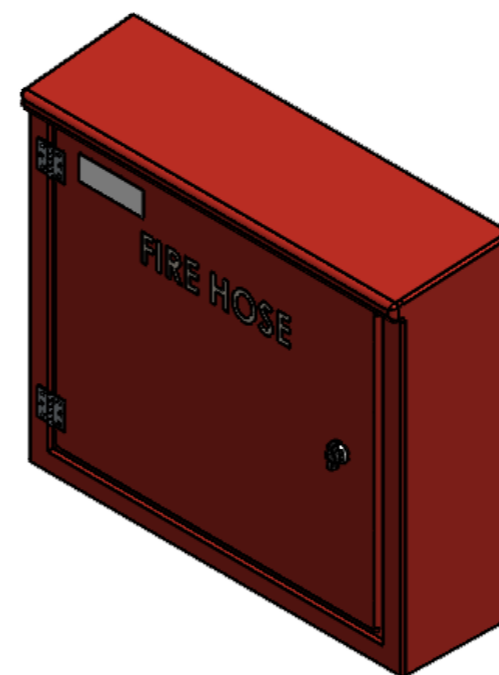

Rear View

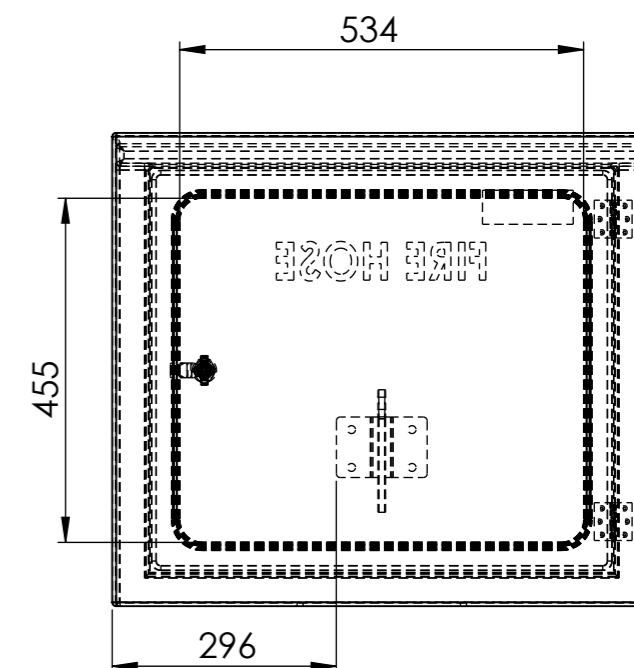

Top View

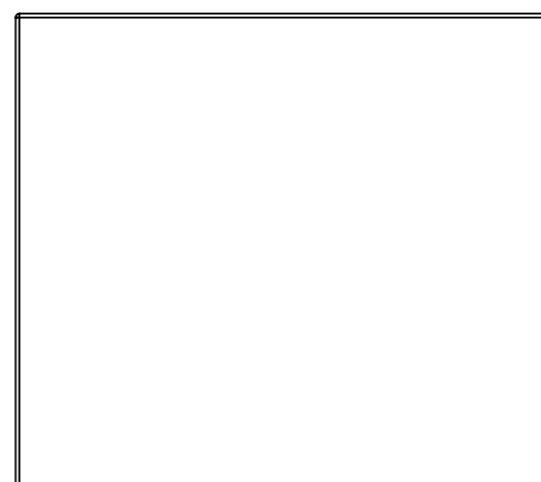
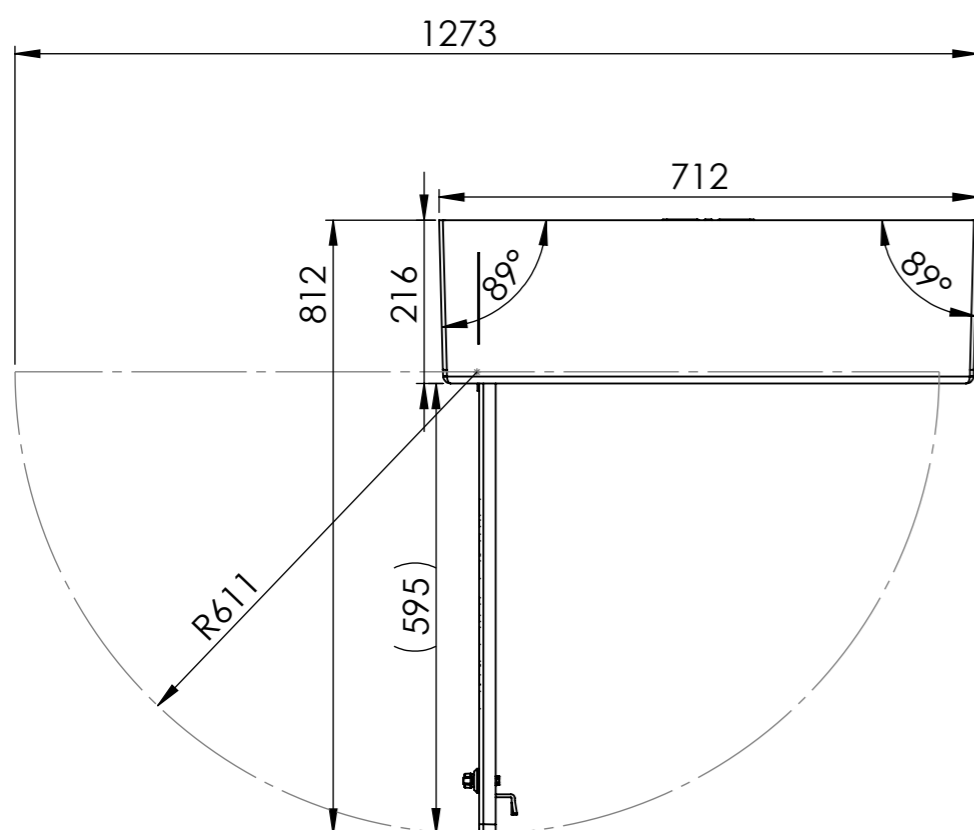

Footprint

Colour	RAL3000
Material	3-4mm GRP
Lock and hinges	Stainless steel
Weight cabinet	xxKg
Weight cabinet incl. content	Invulbaar
C.O.G.	X-348 / Y-79 / Z-314 from datum
Text on cabinet	FIRE HOSE
Tag on cabinet	Invulbaar
Mounting instructions	Invulbaar

Storage for

Dräger	Date	Name	SW Filename
	Drawn 13-10-2023	B. Cool	DMO_40_01
Dräger Nederland B.V. Marine & Offshore Beurtschipperstraat 1 3194 DK, Hoogvliet-RT the Netherlands		Comments: +31 10 2952772	
Scale: 1:10	Projection	Description:	Art.Nr:
Units: mm		DMO_40_00	DMO_40_00
			Sheet 1 of 1
			Format: A3